

COMMON

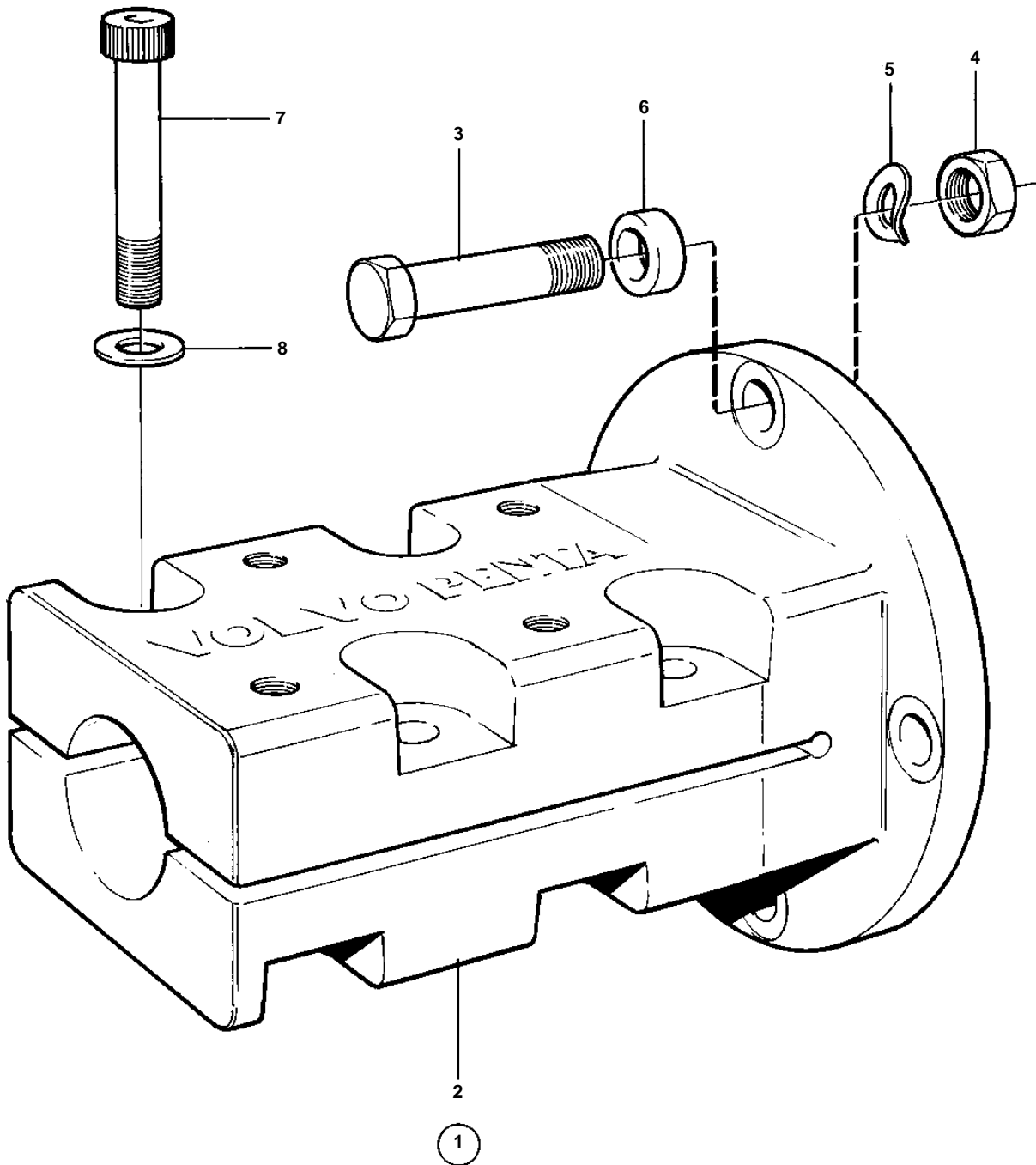

11346

COMMON

REF	PART NO.	QTY	DESCRIPTION	NOTES
1	872943	1	Clamp coupling	
2		1	· Flange	
3	955694	4	· Screw	
4	950375	4	· Nut	
5	941909	4	· Spring washer	EARLY TYPE. Should not be used on KAMD42.
6	860699	4	· Sleeve	L =7mm, FOR HS1A
7	948670	8	· Screw	
8	947345	8	· Washer	